

MODEL :		TYPE
PROJECT :		
PREPARED BY :	DATE :	

SERIES SPECIFICATIONS

4" TYPE "LL" ALUMINUM CONDULET W/ COVER & GASKET



LINE DRAWING

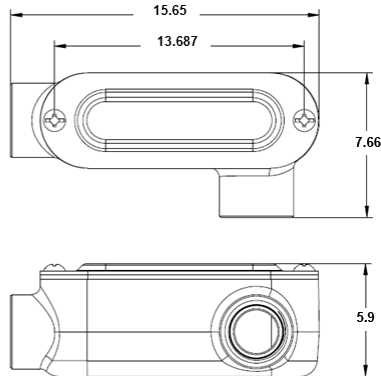

CONSTRUCTION

Material
Die Cast Copper-Free Aluminum

Finish
Powder Coat

Gasket
Neoprene

Type
LL

ORDERING INFORMATION

Part Number: WI LL400

Package Qty: 1 PCS

IMS Code: 0268-3119

APPLICATION AND PERFORMANCE SPECIFICATION INFORMATION IS SUBJECT TO CHANGE WITHOUT NOTIFICATION