

MODEL :		TYPE
PROJECT :		
PREPARED BY :	DATE :	

## SERIES SPECIFICATIONS

WI STL RT COMP CONN 3/4"



## LINE DRAWING

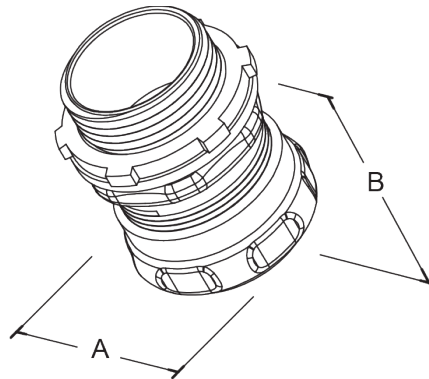

## CONSTRUCTION

Material  
Steel

Finish  
Zinc plated

Trade Size  
3/4"

Connector  
EMT Raintight Compression Connector

Temperature Rating  
105°

Sealing Ring Material  
Zytel 103FHS

## DIMENSION

A (In.)  
1.3

A (mm)  
33.02

B (In.)  
1.64

B (mm)  
41.65

APPLICATION AND PERFORMANCE SPECIFICATION INFORMATION IS SUBJECT TO CHANGE WITHOUT NOTIFICATION

MODEL :		TYPE
PROJECT :		
PREPARED BY :	DATE :	

### DIMENSION (Cont.)

Thread Size  
3/4"-14

Trade Size  
3/4"

### ORDERING INFORMATION

Part Number: WI MECR-751

IMS Code: 2852910

Master Carton Qty: 250 PCS

Pallet Qty: 48 PCS

Master Carton Dimensions: 18.5x10.62x6.88In.

Pallet Dimensions: 45.28x37.4x47.24In.

Product Weight: 2.19Oz.

APPLICATION AND PERFORMANCE SPECIFICATION INFORMATION IS SUBJECT TO CHANGE WITHOUT NOTIFICATION