

MODEL :		TYPE
PROJECT :		
PREPARED BY :	DATE :	

## SERIES SPECIFICATIONS

WI STL RT COMP CONN 1"



## LINE DRAWING

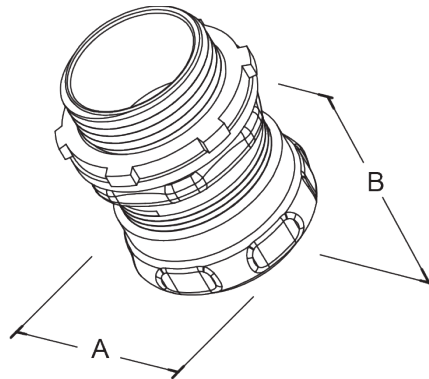

## CONSTRUCTION

Material  
Steel

Finish  
Zinc plated

Trade Size  
1"

Connector  
EMT Raintight Compression Connector

Temperature Rating  
105°

Sealing Ring Material  
Zytel 103FHS

## DIMENSION

A (In.)  
1.63

A (mm)  
41.4

B (In.)  
1.95

B (mm)  
49.53

APPLICATION AND PERFORMANCE SPECIFICATION INFORMATION IS SUBJECT TO CHANGE WITHOUT NOTIFICATION

MODEL :		TYPE
PROJECT :		
PREPARED BY :	DATE :	

### DIMENSION (Cont.)

Thread Size  
1"-11.5

Trade Size  
1"

### ORDERING INFORMATION

Part Number: WI MECR-752

IMS Code: 2852916

Master Carton Qty: 100 PCS

Pallet Qty: 56 PCS

Master Carton Dimensions: 18.5x10.62x5.51In.

Pallet Dimensions: 45.28x37.4x44.49In.

Product Weight: 3.95Oz.

APPLICATION AND PERFORMANCE SPECIFICATION INFORMATION IS SUBJECT TO CHANGE WITHOUT NOTIFICATION