

MODEL :		TYPE
PROJECT :		
PREPARED BY :	DATE :	

SERIES SPECIFICATIONS

5 HOLE TEE GUSSET PLATE



LINE DRAWING

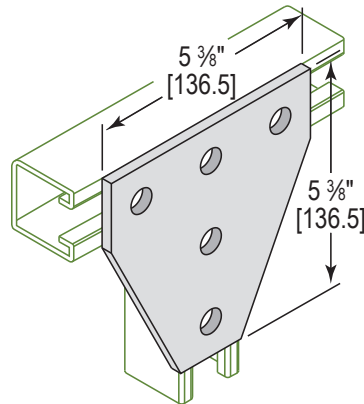

CONSTRUCTION

Type
Tee Gusset

Finish
Electro-galvanized

of Holes
5

DIMENSION

Width (In.)
5 3/8"

Hole Spacing
-

Length (In.)
5 3/8"

Thickness (mm.)
1/4"

APPLICATION AND PERFORMANCE SPECIFICATION INFORMATION IS SUBJECT TO CHANGE WITHOUT NOTIFICATION

MODEL :		TYPE
PROJECT :		
PREPARED BY :	DATE :	

ORDERING INFORMATION

Part Number: F63

Weight (lbs.): 1.39

IMS Code: 0304-8543

APPLICATION AND PERFORMANCE SPECIFICATION INFORMATION IS SUBJECT TO CHANGE WITHOUT NOTIFICATION