

MODEL :		TYPE
PROJECT :		
PREPARED BY :	DATE :	

SERIES SPECIFICATIONS

POST BASE DBL CHAN 4 HOLE STND 1-5/8"



LINE DRAWING

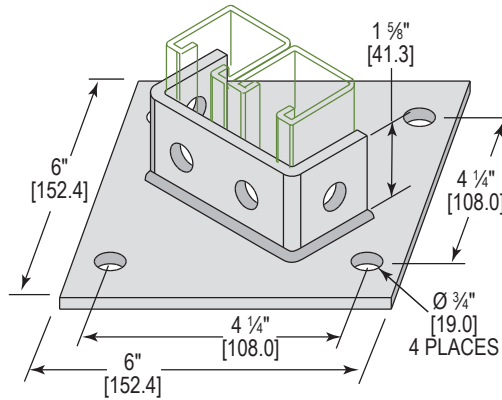

CONSTRUCTION

Finish
Electro-galvanized

Type
Double 4 Hole Standard

DIMENSION

Length (In.)
6

Length (mm.)
152.4

Width (In.)
6

Width (mm.)
152.4

Height (In.)
1 5/8

Height (mm.)
41.3

Hole Diameter (In.)
3/4"

Hole Center to Edge (In.)
0.875

APPLICATION AND PERFORMANCE SPECIFICATION INFORMATION IS SUBJECT TO CHANGE WITHOUT NOTIFICATION

MODEL :		TYPE
PROJECT :		
PREPARED BY :	DATE :	

DIMENSION

Channel Size
1 5/8"

ORDERING INFORMATION

Part Number: P158

Weight (lbs.): 3.1

IMS Code: 0304-8669

APPLICATION AND PERFORMANCE SPECIFICATION INFORMATION IS SUBJECT TO CHANGE WITHOUT NOTIFICATION