

MODEL :		TYPE
PROJECT :		
PREPARED BY :	DATE :	

SERIES SPECIFICATIONS

SQ. WASHER 1/4"

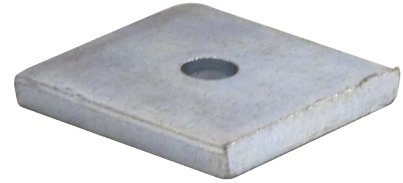

LINE DRAWING

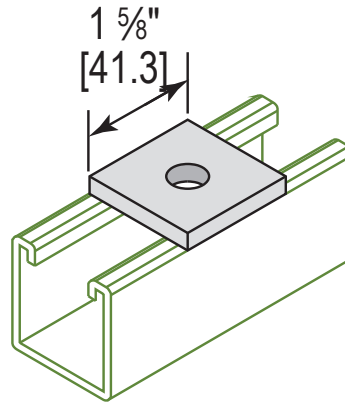

CONSTRUCTION

Finish
304 stainless steel

DIMENSION

Bolt Size (In.)
1/4"

Bolt Size (mm.)
6

Hole Size (In.)
5/16"

Hole Size (mm.)
7.9

Length (In.)
1-5/8"

Thickness (mm.)
1/4"

APPLICATION AND PERFORMANCE SPECIFICATION INFORMATION IS SUBJECT TO CHANGE WITHOUT NOTIFICATION

MODEL :	TYPE
PROJECT :	
PREPARED BY :	DATE :

ORDERING INFORMATION

Part Number: SW25S4

Weight (lbs.): 0.18

IMS Code: 0304-9023

APPLICATION AND PERFORMANCE SPECIFICATION INFORMATION IS SUBJECT TO CHANGE WITHOUT NOTIFICATION