

CONTRACTOR:	
PROJECT:	DATE:
PREPARED BY:	SERIES: PS1000EG

PS1000EG

SPECIFICATION & FEATURES

DESCRIPTION

PIPE STRAP 2 HOLE 10" EG

Country of Origin: US

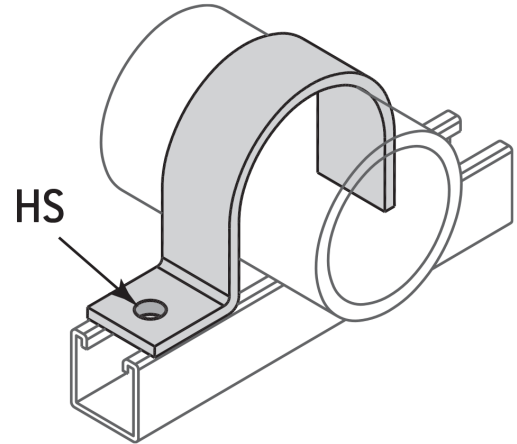

ORDERING INFORMATION

PART # PS1000EG	STOCK CODE 0315-3576	LENGTH None	WIDTH None	HEIGHT None
TRADE SIZE 10 Inches	COLOR Gray	FINISH Electrogalvanized	MATERIAL Carbon Steel	NUMBER OF HOLES 2

APPLICATION AND PERFORMANCE SPECIFICATION INFORMATION IS SUBJECT TO CHANGE WITHOUT NOTIFICATION