

CONTRACTOR:	
PROJECT:	DATE:
PREPARED BY:	SERIES: WI RCC-150M-IC

WI RCC-150M-IC

SPECIFICATION & FEATURES

DESCRIPTION

1-1/2" RIGID COMP CONN - MAL/INS

Country of Origin: CN

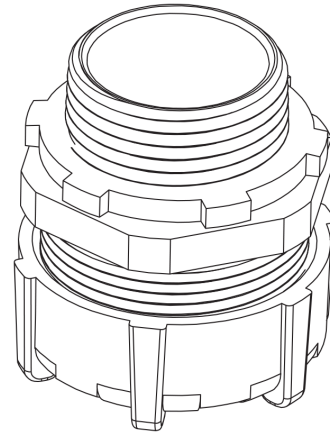

ORDERING INFORMATION

PART # WI RCC-150M-IC	STOCK CODE 0322-6236	LENGTH None	WIDTH None	HEIGHT None
DIAMETER None	TRADE SIZE 1-1/2 in.	SIZE 1-1/2 Inches	COLOR Malleable Iron	CONNECTION Compression
FINISH Malleable Iron	INSULATION Insulated	MATERIAL Malleable		

APPLICATION AND PERFORMANCE SPECIFICATION INFORMATION IS SUBJECT TO CHANGE WITHOUT NOTIFICATION