

CONTRACTOR:	
PROJECT:	DATE:
PREPARED BY:	SERIES: WI RCC-200M-IC

WI RCC-200M-IC

SPECIFICATION & FEATURES

DESCRIPTION

2" RIGID COMP CONN - MAL/INS

Country of Origin: CN

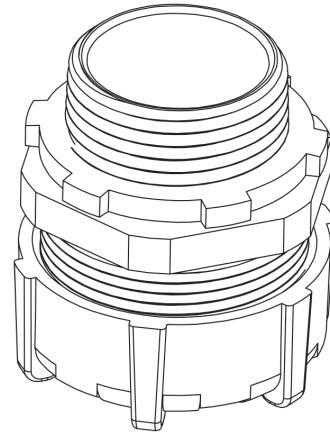

ORDERING INFORMATION

PART # WI RCC-200M-IC	STOCK CODE 0322-6239	LENGTH None	WIDTH None	HEIGHT None
DIAMETER None	TRADE SIZE 2 in.	SIZE 2 Inches	COLOR Malleable Iron	CONNECTION Compression
FINISH Malleable Iron	INSULATION Insulated	MATERIAL Malleable		

APPLICATION AND PERFORMANCE SPECIFICATION INFORMATION IS SUBJECT TO CHANGE WITHOUT NOTIFICATION