

MODEL :		TYPE
PROJECT :		
PREPARED BY :	DATE :	

SERIES SPECIFICATIONS

WI STEEL COUPLING 2-1/2"



LINE DRAWING

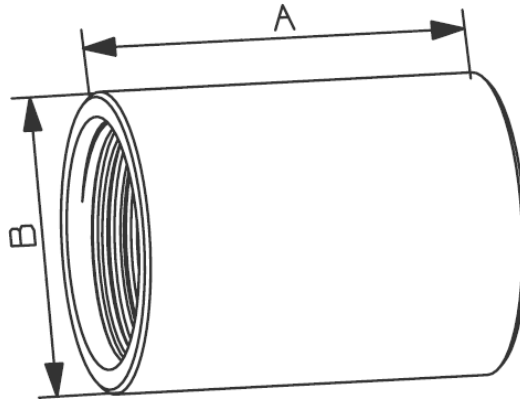

CONSTRUCTION

Material
Cast Steel

Coupling
Steel Coupling

Finish
Zinc Electro-Plated

Trade Size
2-1/2"

DIMENSION

A (In.)
3.187

B (In.)
3.25

APPLICATION AND PERFORMANCE SPECIFICATION INFORMATION IS SUBJECT TO CHANGE WITHOUT NOTIFICATION

MODEL :		TYPE
PROJECT :		
PREPARED BY :	DATE :	

ORDERING INFORMATION

Part Number: WI RC250

IMS Code: 0281-1972

APPLICATION AND PERFORMANCE SPECIFICATION INFORMATION IS SUBJECT TO CHANGE WITHOUT NOTIFICATION



404 NW ENTERPRISE DR. PORT ST. LUCIE, FL 34986 | 772.408.5213 | WWW.CENTAURINSTALLATION.COM