

MODEL :		TYPE
PROJECT :		
PREPARED BY :	DATE :	

SERIES SPECIFICATIONS

BRKT CHAN 1-5/8" CHAN 2 HOLE 6"

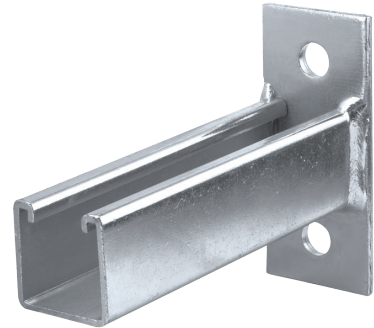

LINE DRAWING

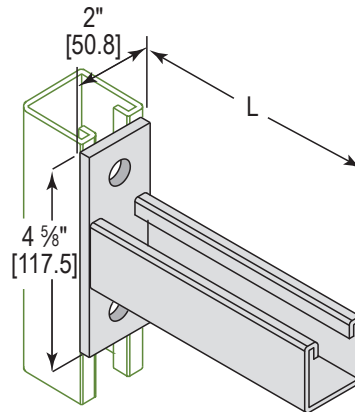

CONSTRUCTION

Finish
Electro-galvanized

Type
2 Hole

DIMENSION

Uniform Load (kN)
5.56

Thickness
1/4"

Width (In.)
2"

Uniform Load (Lbs.)
1250

Length (In.)
6"

Length (mm.)
152.4

Height (mm.)
4 5/8"

APPLICATION AND PERFORMANCE SPECIFICATION INFORMATION IS SUBJECT TO CHANGE WITHOUT NOTIFICATION

MODEL :		TYPE
PROJECT :		
PREPARED BY :		DATE :

ORDERING INFORMATION

Part Number: FCB600EG

Weight (lbs.): 1.85

IMS Code: 0304-8351

APPLICATION AND PERFORMANCE SPECIFICATION INFORMATION IS SUBJECT TO CHANGE WITHOUT NOTIFICATION