

MODEL :		TYPE
PROJECT :		
PREPARED BY :	DATE :	

SERIES SPECIFICATIONS

BRKT CHAN 1-5/8" CHAN 2 HOLE 18"

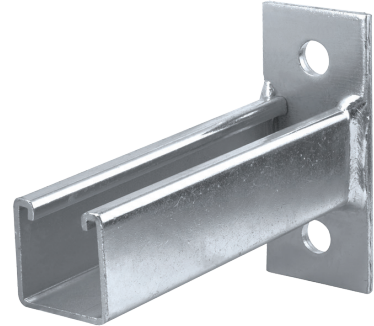

LINE DRAWING

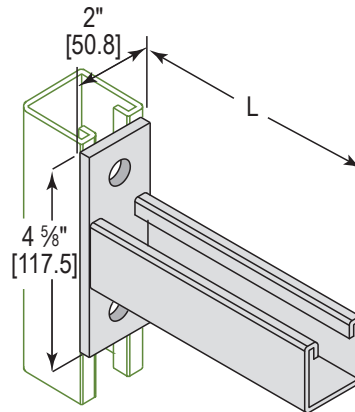

CONSTRUCTION

Finish
Electro-galvanized

Type
2 Hole

DIMENSION

Uniform Load (kN)
2.22

Thickness
1/4"

Width (In.)
2"

Uniform Load (Lbs.)
500

Length (In.)
18"

Length (mm.)
457.2

Height (mm.)
4 5/8"

APPLICATION AND PERFORMANCE SPECIFICATION INFORMATION IS SUBJECT TO CHANGE WITHOUT NOTIFICATION

MODEL :		TYPE
PROJECT :		
PREPARED BY :	DATE :	

ORDERING INFORMATION

Part Number: FCB1800EG

Weight (lbs.): 3.28

IMS Code: 0304-8360

APPLICATION AND PERFORMANCE SPECIFICATION INFORMATION IS SUBJECT TO CHANGE WITHOUT NOTIFICATION