

MODEL :		TYPE
PROJECT :		
PREPARED BY :	DATE :	

SERIES SPECIFICATIONS

NOTCHED SQ. WASHER 1/4"



LINE DRAWING

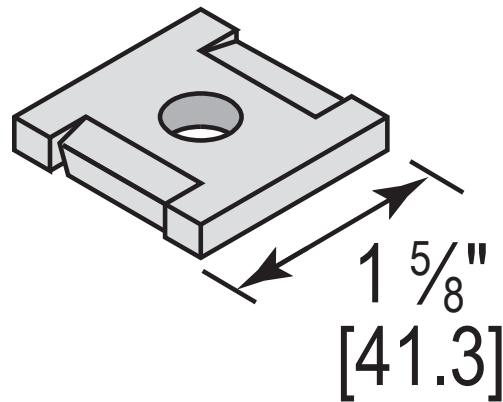

CONSTRUCTION

Finish
Electro-galvanized

DIMENSION

Bolt Size (In.)
1/4"

Bolt Size (mm.)
6

Length (In.)
1-5/8"

Thickness (mm.)
1/4"

APPLICATION AND PERFORMANCE SPECIFICATION INFORMATION IS SUBJECT TO CHANGE WITHOUT NOTIFICATION

MODEL :		TYPE
PROJECT :		
PREPARED BY :	DATE :	

ORDERING INFORMATION

Part Number: NSW25EG

Weight (lbs.): 0.17

IMS Code: 0304-8501

APPLICATION AND PERFORMANCE SPECIFICATION INFORMATION IS SUBJECT TO CHANGE WITHOUT NOTIFICATION