

MODEL :		TYPE
PROJECT :		
PREPARED BY :	DATE :	

SERIES SPECIFICATIONS

2 HOLE 2-5/8" ADJ CORNER ANGLE



LINE DRAWING

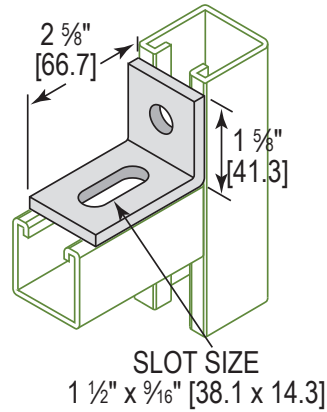

CONSTRUCTION

Type
Adjustable Corner

Finish
Electro-Galvanized

of Holes
2

DIMENSION

Width (In.)
1 5/8"

Slot Size
1 1/2" x 9/16"

Length (In.)
2 5/8"

Thickness (mm.)
1/4"

APPLICATION AND PERFORMANCE SPECIFICATION INFORMATION IS SUBJECT TO CHANGE WITHOUT NOTIFICATION

MODEL :	TYPE
PROJECT :	
PREPARED BY :	DATE :

ORDERING INFORMATION

Part Number: AF20

Weight (lbs.): 0.35

IMS Code: 0304-8576

APPLICATION AND PERFORMANCE SPECIFICATION INFORMATION IS SUBJECT TO CHANGE WITHOUT NOTIFICATION