

MODEL :		TYPE
PROJECT :		
PREPARED BY :	DATE :	

SERIES SPECIFICATIONS

1 HOLE 5-7/8" CORNER ANGLE



LINE DRAWING

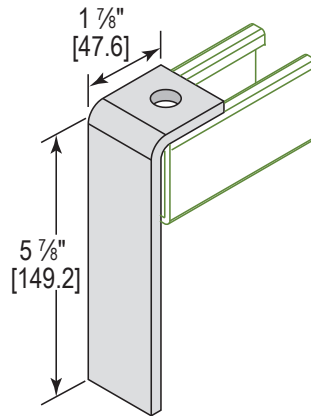

CONSTRUCTION

Type
5 7/8" Corner

Finish
Electro-Galvanized

of Holes
1

DIMENSION

Width (In.)
1 5/8"

Slot Size
9/16"

Length (In.)
1 7/8"

Thickness (mm.)
1/4"

APPLICATION AND PERFORMANCE SPECIFICATION INFORMATION IS SUBJECT TO CHANGE WITHOUT NOTIFICATION

MODEL :	TYPE	
PROJECT :		
PREPARED BY :	DATE :	

ORDERING INFORMATION

Part Number: AF37

Weight (lbs.): 0.85

IMS Code: 0304-8627

APPLICATION AND PERFORMANCE SPECIFICATION INFORMATION IS SUBJECT TO CHANGE WITHOUT NOTIFICATION