

MODEL :		TYPE
PROJECT :		
PREPARED BY :	DATE :	

## SERIES SPECIFICATIONS

8" ANGLE BRACE



## LINE DRAWING

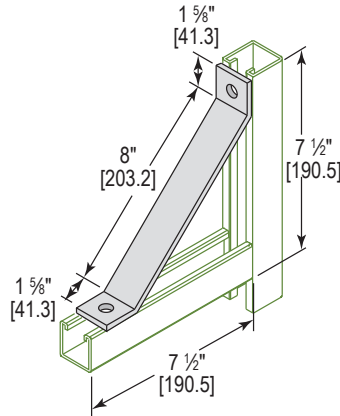

## CONSTRUCTION

Type  
Angle Brace

Finish  
Electro-Galvanized

# of Holes  
2

## DIMENSION

Width (In.)  
1 5/8"

Slot Size  
9/16"

Length (In.)  
7 1/2"

Thickness (mm.)  
1/4"

APPLICATION AND PERFORMANCE SPECIFICATION INFORMATION IS SUBJECT TO CHANGE WITHOUT NOTIFICATION

MODEL :	TYPE
PROJECT :	
PREPARED BY :	DATE :

ORDERING INFORMATION

Part Number: AF40

Weight (lbs.): 1.19

IMS Code: 0304-8636

APPLICATION AND PERFORMANCE SPECIFICATION INFORMATION IS SUBJECT TO CHANGE WITHOUT NOTIFICATION