

MODEL :		TYPE
PROJECT :		
PREPARED BY :	DATE :	

SERIES SPECIFICATIONS

12" ANGLE BRACE



LINE DRAWING

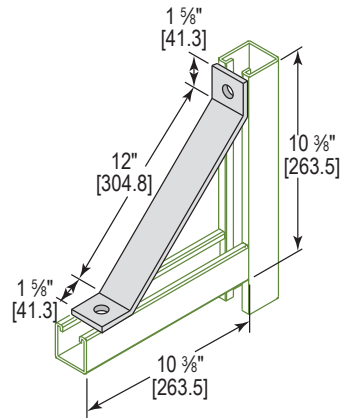

CONSTRUCTION

Type
Angle Brace

Finish
Electro-Galvanized

of Holes
2

DIMENSION

Width (In.)
1 5/8"

Slot Size
9/16"

Length (In.)
10 3/8"

Thickness (mm.)
1/4"

APPLICATION AND PERFORMANCE SPECIFICATION INFORMATION IS SUBJECT TO CHANGE WITHOUT NOTIFICATION

MODEL :		TYPE
PROJECT :		
PREPARED BY :	DATE :	

ORDERING INFORMATION

Part Number: AF41

Weight (lbs.): 1.65

IMS Code: 0304-8639

APPLICATION AND PERFORMANCE SPECIFICATION INFORMATION IS SUBJECT TO CHANGE WITHOUT NOTIFICATION