

MODEL :		TYPE
PROJECT :		
PREPARED BY :	DATE :	

SERIES SPECIFICATIONS

PIPE STRAP 3"



LINE DRAWING

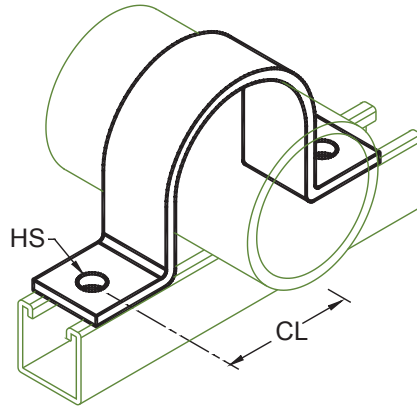

CONSTRUCTION

Finish
Electro-galvanized

DIMENSION

Pipe Size (In.)
3"

Pipe Size (mm.)
80

CL (In.)
2-11/16"

CL (mm.)
68.3

HS (In.)
7/16"

HS (mm.)
11.1

APPLICATION AND PERFORMANCE SPECIFICATION INFORMATION IS SUBJECT TO CHANGE WITHOUT NOTIFICATION

MODEL :	TYPE
PROJECT :	
PREPARED BY :	DATE :

ORDERING INFORMATION

Part Number: PS300EG

Weight (lbs.): 1.33

IMS Code: 0304-8702

APPLICATION AND PERFORMANCE SPECIFICATION INFORMATION IS SUBJECT TO CHANGE WITHOUT NOTIFICATION