

MODEL :		TYPE
PROJECT :		
PREPARED BY :	DATE :	

SERIES SPECIFICATIONS

1 PC UNV STRUT CLAMP 3-1/2"

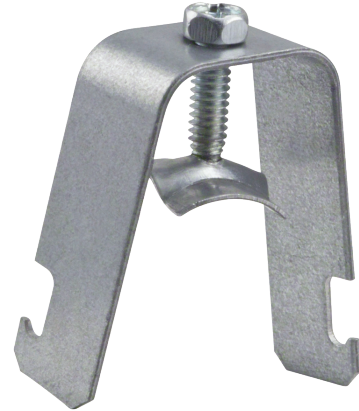

LINE DRAWING

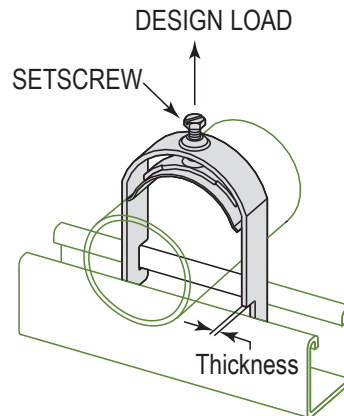

CONSTRUCTION

Type
One Piece Universal

Design Load (Lbs.)
400

Design Load - kN
1.78

Finish
Electro-galvanized

DIMENSION

EMT Size (In.)
3-1/2"

EMT Size (mm.)
90

Thickness (ga.)
12 Ga.

Thickness (mm.)
2.6

Rigid Conduit Size (In.)
3-1/2"

Rigid Conduit Size (mm.)
90

APPLICATION AND PERFORMANCE SPECIFICATION INFORMATION IS SUBJECT TO CHANGE WITHOUT NOTIFICATION

MODEL :		TYPE
PROJECT :		
PREPARED BY :	DATE :	

ORDERING INFORMATION

Part Number: OPUSC350EG

Weight (lbs.): 33.3

IMS Code: 0304-8783

APPLICATION AND PERFORMANCE SPECIFICATION INFORMATION IS SUBJECT TO CHANGE WITHOUT NOTIFICATION