

MODEL :		TYPE
PROJECT :		
PREPARED BY :	DATE :	

## SERIES SPECIFICATIONS

RIGID STRUT CLAMP 1-1/2"



## LINE DRAWING

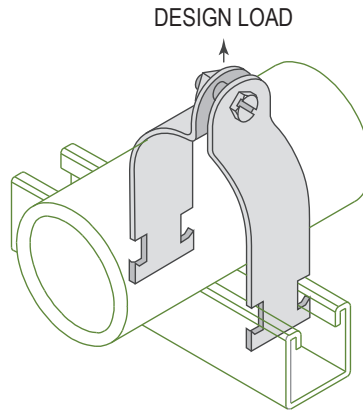

## CONSTRUCTION

Type  
Rigid

Design Load (Lbs.)  
800

Design Load - kN  
3.56

Finish  
Electro-Galvanized

## DIMENSION

Size (In.)  
1-1/2"

Size (mm.)  
40

O.D. (In.)  
1.9

O.D. (mm.)  
48.3

APPLICATION AND PERFORMANCE SPECIFICATION INFORMATION IS SUBJECT TO CHANGE WITHOUT NOTIFICATION

MODEL :		TYPE
PROJECT :		
PREPARED BY :	DATE :	

ORDERING INFORMATION

Part Number: RSC150EG

Weight (lbs.): 0.29

IMS Code: 0304-8807

APPLICATION AND PERFORMANCE SPECIFICATION INFORMATION IS SUBJECT TO CHANGE WITHOUT NOTIFICATION