

MODEL :		TYPE
PROJECT :		
PREPARED BY :	DATE :	

SERIES SPECIFICATIONS

RIGID STRUT CLAMP 1/2"



LINE DRAWING

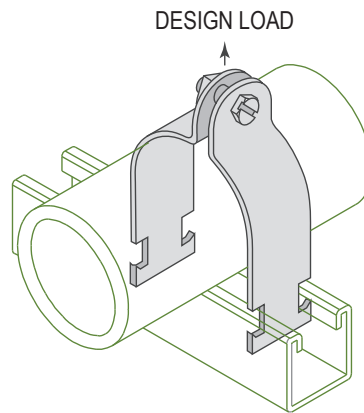

CONSTRUCTION

Type
Rigid

Design Load (Lbs.)
400

Design Load - kN
1.78

Finish
Hot-dip Galvanized

DIMENSION

Size (In.)
1/2"

Size (mm.)
15

O.D. (In.)
0.84

O.D. (mm.)
21.3

APPLICATION AND PERFORMANCE SPECIFICATION INFORMATION IS SUBJECT TO CHANGE WITHOUT NOTIFICATION

MODEL :		TYPE
PROJECT :		
PREPARED BY :	DATE :	

ORDERING INFORMATION

Part Number: RSC050HD

Weight (lbs.): 0.1

IMS Code: 0304-8924

APPLICATION AND PERFORMANCE SPECIFICATION INFORMATION IS SUBJECT TO CHANGE WITHOUT NOTIFICATION