

MODEL :		TYPE
PROJECT :		
PREPARED BY :	DATE :	

SERIES SPECIFICATIONS

RIGID STRUT CLAMP 2"



LINE DRAWING

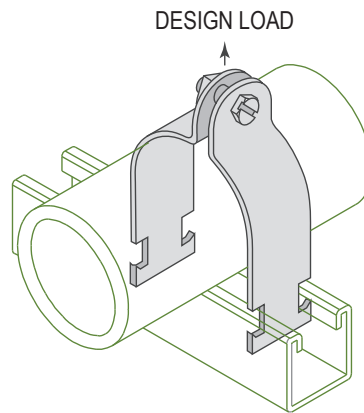

CONSTRUCTION

Type
Rigid

Design Load (Lbs.)
800

Design Load - kN
3.56

Finish
Hot-dip Galvanized

DIMENSION

Size (In.)
2"

Size (mm.)
50

O.D. (In.)
2.375

O.D. (mm.)
60.3

APPLICATION AND PERFORMANCE SPECIFICATION INFORMATION IS SUBJECT TO CHANGE WITHOUT NOTIFICATION

MODEL :		TYPE
PROJECT :		
PREPARED BY :	DATE :	

ORDERING INFORMATION

Part Number: RSC200HD

Weight (lbs.): 0.33

IMS Code: 0304-8939

APPLICATION AND PERFORMANCE SPECIFICATION INFORMATION IS SUBJECT TO CHANGE WITHOUT NOTIFICATION