

MODEL :		TYPE
PROJECT :		
PREPARED BY :	DATE :	

## SERIES SPECIFICATIONS

RIGID STRUT CLAMP 5"



## LINE DRAWING

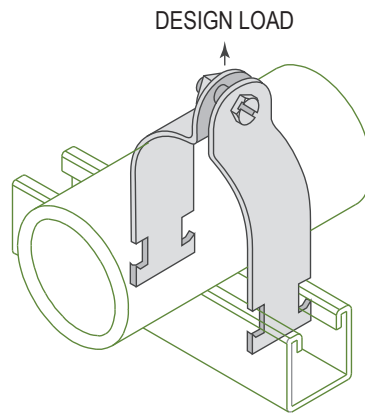

## CONSTRUCTION

Type	Rigid	Design Load (Lbs.)	1000
Design Load - kN	4.45	Finish	Hot-dip Galvanized

## DIMENSION

Size (In.)	5"	Size (mm.)	125
O.D. (In.)	5.562	O.D. (mm.)	141.3

APPLICATION AND PERFORMANCE SPECIFICATION INFORMATION IS SUBJECT TO CHANGE WITHOUT NOTIFICATION

MODEL :		TYPE
PROJECT :		
PREPARED BY :	DATE :	

ORDERING INFORMATION

Part Number: RSC500HD

Weight (lbs.): 0.73

IMS Code: 0304-8954

APPLICATION AND PERFORMANCE SPECIFICATION INFORMATION IS SUBJECT TO CHANGE WITHOUT NOTIFICATION