

MODEL :		TYPE
PROJECT :		
PREPARED BY :	DATE :	

SERIES SPECIFICATIONS

RIGID STRUT CLAMP 1-1/4"



LINE DRAWING

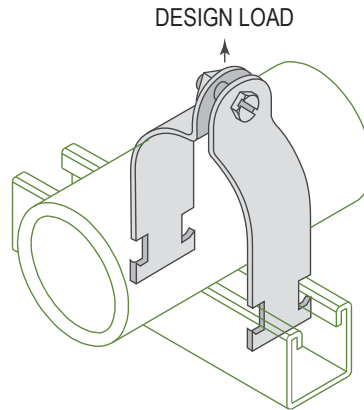

CONSTRUCTION

Type
Rigid

Design Load (Lbs.)
600

Design Load - kN
2.67

Finish
304 stainless steel

DIMENSION

Size (In.)
1-1/4"

Size (mm.)
32

O.D. (In.)
1.66

O.D. (mm.)
42.2

APPLICATION AND PERFORMANCE SPECIFICATION INFORMATION IS SUBJECT TO CHANGE WITHOUT NOTIFICATION

MODEL :		TYPE
PROJECT :		
PREPARED BY :	DATE :	

ORDERING INFORMATION

Part Number: RSC125S4

Weight (lbs.): 0.17

IMS Code: 0304-9071

APPLICATION AND PERFORMANCE SPECIFICATION INFORMATION IS SUBJECT TO CHANGE WITHOUT NOTIFICATION