

MODEL :		TYPE
PROJECT :		
PREPARED BY :	DATE :	

SERIES SPECIFICATIONS

RIGID STRUT CLAMP 3"



LINE DRAWING

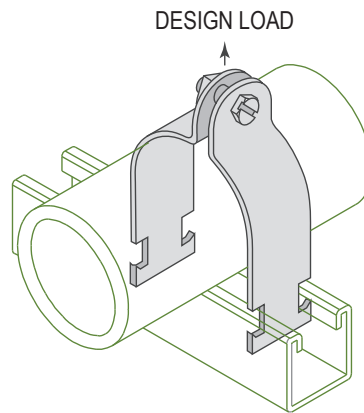

CONSTRUCTION

Type
Rigid

Design Load (Lbs.)
800

Design Load - kN
3.56

Finish
304 stainless steel

DIMENSION

Size (In.)
3"

Size (mm.)
80

O.D. (In.)
3.5

O.D. (mm.)
88.9

APPLICATION AND PERFORMANCE SPECIFICATION INFORMATION IS SUBJECT TO CHANGE WITHOUT NOTIFICATION

MODEL :		TYPE
PROJECT :		
PREPARED BY :	DATE :	

ORDERING INFORMATION

Part Number: RSC300S4

Weight (lbs.): 0.43

IMS Code: 0304-9083

APPLICATION AND PERFORMANCE SPECIFICATION INFORMATION IS SUBJECT TO CHANGE WITHOUT NOTIFICATION