

MODEL :		TYPE
PROJECT :		
PREPARED BY :	DATE :	

SERIES SPECIFICATIONS

RIGID STRUT CLAMP 3/4"



LINE DRAWING

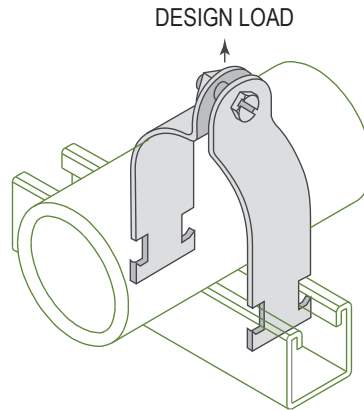

CONSTRUCTION

Type
Rigid

Design Load (Lbs.)
600

Design Load - kN
2.67

Finish
316 stainless steel

DIMENSION

Size (In.)
3/4"

Size (mm.)
20

O.D. (In.)
1.05

O.D. (mm.)
26.7

APPLICATION AND PERFORMANCE SPECIFICATION INFORMATION IS SUBJECT TO CHANGE WITHOUT NOTIFICATION

MODEL :		TYPE
PROJECT :		
PREPARED BY :	DATE :	

ORDERING INFORMATION

Part Number: RSC075S6

Weight (lbs.): 0.13

IMS Code: 0304-9131

APPLICATION AND PERFORMANCE SPECIFICATION INFORMATION IS SUBJECT TO CHANGE WITHOUT NOTIFICATION