

MODEL :		TYPE
PROJECT :		
PREPARED BY :	DATE :	

SERIES SPECIFICATIONS

RIGID STRUT CLAMP 1"



LINE DRAWING

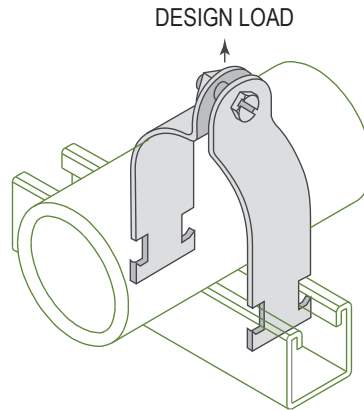

CONSTRUCTION

Type
Rigid

Design Load (Lbs.)
600

Design Load - kN
2.67

Finish
316 stainless steel

DIMENSION

Size (In.)
1"

Size (mm.)
25

O.D. (In.)
1.315

O.D. (mm.)
33.4

APPLICATION AND PERFORMANCE SPECIFICATION INFORMATION IS SUBJECT TO CHANGE WITHOUT NOTIFICATION

MODEL :		TYPE
PROJECT :		
PREPARED BY :	DATE :	

ORDERING INFORMATION

Part Number: RSC100S6

Weight (lbs.): 0.15

IMS Code: 0304-9134

APPLICATION AND PERFORMANCE SPECIFICATION INFORMATION IS SUBJECT TO CHANGE WITHOUT NOTIFICATION