

MODEL :		TYPE
PROJECT :		
PREPARED BY :	DATE :	

SERIES SPECIFICATIONS

RIGID STRUT CLAMP 1-1/2"



LINE DRAWING

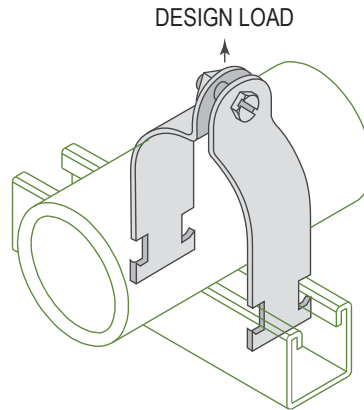

CONSTRUCTION

Type
Rigid

Design Load (Lbs.)
800

Design Load - kN
3.56

Finish
316 stainless steel

DIMENSION

Size (In.)
1-1/2"

Size (mm.)
40

O.D. (In.)
1.9

O.D. (mm.)
48.3

APPLICATION AND PERFORMANCE SPECIFICATION INFORMATION IS SUBJECT TO CHANGE WITHOUT NOTIFICATION

MODEL :		TYPE
PROJECT :		
PREPARED BY :	DATE :	

ORDERING INFORMATION

Part Number: RSC150S6

Weight (lbs.): 0.29

IMS Code: 0304-9140

APPLICATION AND PERFORMANCE SPECIFICATION INFORMATION IS SUBJECT TO CHANGE WITHOUT NOTIFICATION