

MODEL :		TYPE
PROJECT :		
PREPARED BY :	DATE :	

## SERIES SPECIFICATIONS

RIGID STRUT CLAMP 3"



## LINE DRAWING

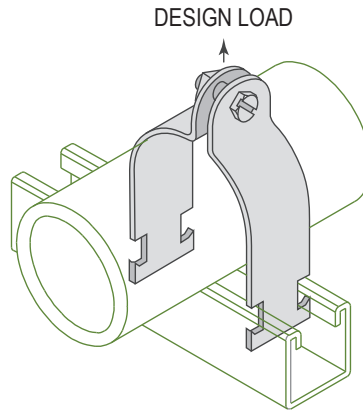

## CONSTRUCTION

Type  
Rigid

Design Load (Lbs.)  
800

Design Load - kN  
3.56

Finish  
316 stainless steel

## DIMENSION

Size (In.)  
3"

Size (mm.)  
80

O.D. (In.)  
3.5

O.D. (mm.)  
88.9

APPLICATION AND PERFORMANCE SPECIFICATION INFORMATION IS SUBJECT TO CHANGE WITHOUT NOTIFICATION

MODEL :		TYPE
PROJECT :		
PREPARED BY :	DATE :	

ORDERING INFORMATION

Part Number: RSC300S6

Weight (lbs.): 0.43

IMS Code: 0304-9149

APPLICATION AND PERFORMANCE SPECIFICATION INFORMATION IS SUBJECT TO CHANGE WITHOUT NOTIFICATION